

Black Guard™



**PVC COATED CONDUIT
SYSTEMS**



Black Guard™

NEC INC.

CONTACTS

Keith Conley – VP Sales

keith@nec-inc.com

Elizabeth Herrada – Inside Sales Manager

elizabeth@nec-inc.com

Bradley Cavnar – Inside Sales

bradley@nec-inc.com

Accounts Payable

accounting@nec-inc.com

7207 West Road

Houston, TX 77086

Phone: 281-405-8240

www.nec-inc.com

PVC COATED CONDUIT SYSTEMS

NEC provides superior interior and exterior coating services for virtually any steel or aluminum electrical conduit system in highly corrosive environments.

OUR SERVICE:

NEC is well respected in the industry for personal service, attention to detail and rapid response to customer orders. Our dedicated efforts in those areas have served us well with steady, profitable business growth through exceptional customer satisfaction.

The advanced proprietary coating process by NEC delivers extraordinary maintenance efficiencies and extended life cycle for electrical systems exposed and susceptible to corrosive environments and problems, helping to alleviate costly repairs and downtime.

BlackGuard is produced under strict quality control procedures in a state of the art production facility in Houston, Texas. The coating is applied incorporating our quality control procedures, computer and temperature controlled settings, and quality individual personal inspections to insure meeting and exceeding high NEC standards.



BENEFITS OF BLACKGUARD:

- Corrosion resistance
- Extends life of product
- Eliminates or reduces plant shutdown
- Helps prevent accidents

ADVANCED PROCESS:

BlackGuard coated conduit is UL listed, File #E100475, and complies with NEMA RN-1 and ANSI C80.1. The conduit has an external coating of dark gray PVC, with minimum thickness of 40-mils. The underlying galvanized threads are additionally treated with clear urethane.

The interior diameter of **BlackGuard** coated conduit has a 2-mil urethane interior coating. This advanced proprietary coating process by NEC delivers extraordinary maintenance efficiencies for systems exposed and susceptible to corrosive environments and problems, helping to alleviate costly repairs and downtime.

BlackGuard PVC Coated Conduit**

Part Number	SIZE	Metric	Wall Thickness	O.D. w/Coating	Inside Diameter	Weight per 100ft	Ft. per Bundle	ALUMINIM Part Number
PVC-GRC-050	1/2"	16	85.0	0.92	0.632	90	2290	PVC-ARC-050
PVC-GRC-075	3/4"	21	112.0	1.13	0.836	119	1790	PVC-ARC-075
PVC-GRC-100	1"	27	164.0	1.95	1.063	175	1270	PVC-ARC-100
PVC-GRC-125	1-1/4"	35	217.0	1.74	1.394	237	910	PVC-ARC-125
PVC-GRC-150	1-1/2"	41	268.0	1.98	1.624	281	790	PVC-ARC-150
PVC-GRC-200	2"	53	358.0	2.455	2.083	376	610	PVC-ARC-200
PVC-GRC-250	2-1/2"	63	546.0	2.955	2.489	593	370	PVC-ARC-250
PVC-GRC-300	3"	78	708.0	3.58	3.09	772	290	PVC-ARC-300
PVC-GRC-350	3-1/2"	91	851.0	4.08	3.57	922	190	PVC-ARC-350
PVC-GRC-400	4"	103	1009.0	4.58	4.05	1089	190	PVC-ARC-400
PVC-GRC-500	5"	129	1337.0	5.643	5.073	1488	100	PVC-ARC-500
PVC-GRC-600	6"	155	1993.0	6.705	6.093	1998	100	PVC-ARC-600

**Note: One coupling is included with each 10'ft length conduit

BlackGuard PVC Coated Conduit Couplings

Part Number	SIZE	Metric	Metal	Per Inch	Weight per 100	Box Qty	ALUMINIM Part Number
PVC-CG-050	1/2"	16	1.5	14.0	19	90	PVC-AC-050
PVC-CG-075	3/4"	21	1.532	14.0	32	50	PVC-AC-075
PVC-CG-100	1"	27	1.906	11.5	40	30	PVC-AC-100
PVC-CG-125	1-1/4"	35	1.906	11.5	50	25	PVC-AC-125
PVC-CG-150	1-1/2"	41	1.906	11.5	69	25	PVC-AC-150
PVC-CG-200	2"	53	1.937	11.5	93	15	PVC-AC-200
PVC-CG-250	2-1/2"	63	2.878	8.0	233	10	PVC-AC-250
PVC-CG-300	3"	78	3.031	8.0	317	8	PVC-AC-300
PVC-CG-350	3-1/2"	91	3.094	8.0	422	8	PVC-AC-350
PVC-CG-400	4"	103	3.188	8.0	433.5	Bulk	PVC-AC-400
PVC-CG-500	5"	129	3.374	8.0	550	Bulk	PVC-AC-500
PVC-CG-600	6"	155	3.437	8.0	884	Bulk	PVC-AC-600



BlackGuard PVC Coated Conduit Elbows*

Part Number	SIZE	Metric	Standard Radius A	Offset B	Tangent C	Weight per 100	ALUMINIM Part Number
PVC-GE-05090	1/2"	16	4.25	6.0	1.7	70	PVC-AE-05090
PVC-GE-07590	3/4"	21	4.5	6.7	2.2	100	PVC-AE-07590
PVC-GE-10090	1"	27	5.75	8.0	2.4	190	PVC-AE-10090
PVC-GE-12590	1-1/4"	35	7.25	9.6	2.8	310	PVC-AE-12590
PVC-GE-15090	1-1/2"	41	8.25	10.6	2.6	400	PVC-AE-15090
PVC-GE-20090	2"	53	9.5	12.0	3.5	640	PVC-AE-20090
PVC-GE-25090	2-1/2"	63	10.5	14.8	4.7	1210	PVC-AE-25090
PVC-GE-30090	3"	78	13	17.0	5.3	1950	PVC-AE-30090
PVC-GE-35090	3-1/2"	91	15	20.9	6.1	2630	PVC-AE-35090
PVC-GE-40090	4"	103	16	21.0	6.5	3280	PVC-AE-40090
PVC-GE-50090	5"	129	24	32.0	11.2	6750	PVC-AE-50090
PVC-GE-60090	6"	155	30	41.0	1.1	10510	PVC-AE-60090



*All weights based on rigid steel conduit & fittings – Aluminum weights available by request.

BlackGuard PVC Coated Galvanized Large Radius Elbows*

TRADE SIZE	RADIUS							
	12"		15"		18"		24"	
	GRC PART NUMBER	WT	GRC PART NUMBER	WT	GRC PART NUMBER	WT	GRC PART NUMBER	WT
1"	PVC-GE-1009012	4	PVC-GE-1009015	6	PVC-GE-1009018	6	PVC-GE-1009024	8
1-1/4"	PVC-GE-1259012	5	PVC-GE-1259015	7	PVC-GE-1259018	9	PVC-GE-1259024	11
1-1/2"	PVC-GE-1509012	7	PVC-GE-1509015	9	PVC-GE-1509018	10	PVC-GE-1509024	13
2"	PVC-GE-2009012	10	PVC-GE-2009015	12	PVC-GE-2009018	14	PVC-GE-2009024	17
2-1/2"	PVC-GE-2509012	17	PVC-GE-2509015	19	PVC-GE-2509018	21	PVC-GE-2509024	26
3"	PVC-GE-3009012	23	PVC-GE-3009015	25	PVC-GE-3009018	28	PVC-GE-3009024	35
3-1/2"					PVC-GE-3509018	34	PVC-GE-3509024	42
4"					PVC-GE-4009018	40	PVC-GE-4009024	49

TRADE SIZE	RADIUS							
	30"		36"		48"		60"	
	GRC PART NUMBER	WT	GRC PART NUMBER	WT	GRC PART NUMBER	WT	GRC PART NUMBER	WT
1"	PVC-GE-1009030	9	PVC-GE-1009036	10	PVC-GE-1009048	13	PVC-GE-1009060	15
1-1/4"	PVC-GE-1259030	12	PVC-GE-1259036	14	PVC-GE-1259048	18	PVC-GE-1259060	20
1-1/2"	PVC-GE-1509030	15	PVC-GE-1509036	17	PVC-GE-1509048	21	PVC-GE-1509060	24
2"	PVC-GE-2009030	20	PVC-GE-2009036	22	PVC-GE-2009048	29	PVC-GE-2009060	33
2-1/2"	PVC-GE-2509030	31	PVC-GE-2509036	35	PVC-GE-2509048	45	PVC-GE-2509060	51
3"	PVC-GE-3009030	41	PVC-GE-3009036	46	PVC-GE-3009048	59	PVC-GE-3009060	67
3-1/2"	PVC-GE-3509030	49	PVC-GE-3509036	55	PVC-GE-3509048	71	PVC-GE-3509060	90
4"	PVC-GE-4009030	58	PVC-GE-4009036	65	PVC-GE-4009048	84	PVC-GE-4009060	93
5"	PVC-GE-5009030	77	PVC-GE-5009036	87	PVC-GE-5009048	112	PVC-GE-5009060	126
6"			PVC-GE-6009036	120	PVC-GE-6009048	156	PVC-GE-6009060	172

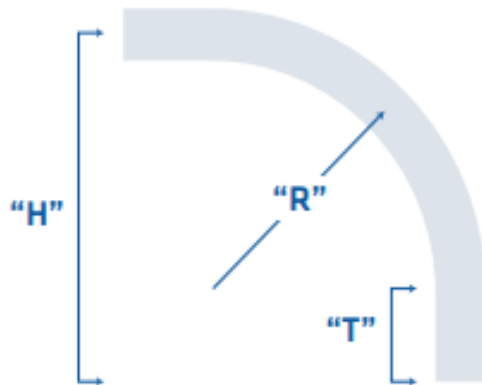

BlackGuard PVC Coated Nipples

GRC PART NUMBER	TRADE SIZE	Wt. per 100	ALUMINUM PART NUMBER
PVC-GN-050 CL	1/2" X CL (1-1/8")	6	PVC-AN-050 CL
PVC-GN-05001N	1/2" X 1-1/2"	8	PVC-AN-05001N
PVC-GN-05002	1/2" X 2"	12	PVC-AN-05002
PVC-GN-05002N	1/2" X 2-1/2"	15	PVC-AN-05002N
PVC-GN-05003	1/2" X 3"	19	PVC-AN-05003
PVC-GN-05003N	1/2" X 3-1/2"	22	PVC-AN-05003N
PVC-GN-05004	1/2" X 4"	26	PVC-AN-05004
PVC-GN-05005	1/2" X 5"	33	PVC-AN-05005
PVC-GN-05006	1/2" X 6"	40	PVC-AN-05006
PVC-GN-05008	1/2" X 8"	54	PVC-AN-05008
PVC-GN-05010	1/2" X 10"	68	PVC-AN-05010
PVC-GN-05012	1/2" X 12"	82	PVC-AN-05012
GRC PART NUMBER	TRADE SIZE	Wt. per 100	ALUMINUM PART NUMBER
PVC-GN-125 CL	1-1/4" X CL (1-5/8")	22	PVC-AN-125 CL
PVC-GN-12502	1-1/4" X 2"	28	PVC-AN-12502
PVC-GN-12502N	1-1/4" X 2-1/2"	37	PVC-AN-12502N
PVC-GN-12503	1-1/4" X 3"	47	PVC-AN-12503
PVC-GN-12503N	1-1/4" X 3-1/2"	55	PVC-AN-12503N
PVC-GN-12504	1-1/4" X 4"	66	PVC-AN-12504
PVC-GN-12505	1-1/4" X 5"	84	PVC-AN-12505
PVC-GN-12506	1-1/4" X 6"	100	PVC-AN-12506
PVC-GN-12508	1-1/4" X 8"	136	PVC-AN-12508
PVC-GN-12510	1-1/4" X 10"	176	PVC-AN-12510
PVC-GN-12512	1-1/4" X 12"	216	PVC-AN-12512
GRC PART NUMBER	TRADE SIZE	Wt. per 100	ALUMINUM PART NUMBER
PVC-GN-250 CL	2-1/2" X CL (2-1/2")	84	PVC-AN-250 CL
PVC-GN-25003	2-1/2" X 3"	100	PVC-AN-25003
PVC-GN-25003N	2-1/2" X 3-1/2"	120	PVC-AN-25003N
PVC-GN-25004	2-1/2" X 4"	150	PVC-AN-25004
PVC-GN-25005	2-1/2" X 5"	197	PVC-AN-25005
PVC-GN-25006	2-1/2" X 6"	240	PVC-AN-25006
PVC-GN-25008	2-1/2" X 8"	329	PVC-AN-25008
PVC-GN-25010	2-1/2" X 10"	422	PVC-AN-25010
PVC-GN-25012	2-1/2" X 12"	505	PVC-AN-25012
PVC-GN-15010	1-1/2" X 10"	216	PVC-AN-15010
PVC-GN-15012	1-1/2" X 12"	260	PVC-AN-15012
GRC PART NUMBER	TRADE SIZE	Wt. per 100	ALUMINUM PART NUMBER
PVC-GN-400 CL	4" X CL (2-7/8")	180	PVC-AN-400 CL
PVC-GN-40004	4" X 4"	285	PVC-AN-40004
PVC-GN-40005	4" X 5"	380	PVC-AN-40005
PVC-GN-40006	4" X 6"	440	PVC-AN-40006
PVC-GN-40008	4" X 8"	600	PVC-AN-40008
PVC-GN-40010	4" X 10"	775	PVC-AN-40010
PVC-GN-40012	4" X 12"	925	PVC-AN-40012

GRC PART NUMBER	TRADE SIZE	Wt. per 100	ALUMINUM PART NUMBER
PVC-GN-075 CL	3/4" X CL (1-3/8")	9	PVC-AN-075 CL
PVC-GN-07501N	3/4" X 1-1/2"	9	PVC-AN-07501N
PVC-GN-07502	3/4" X 2"	14	PVC-AN-07502
PVC-GN-07502N	3/4" X 2-1/2"	19	PVC-AN-07502N
PVC-GN-07503	3/4" X 3"	24	PVC-AN-07503
PVC-GN-07503N	3/4" X 3-1/2"	28	PVC-AN-07503N
PVC-GN-07504	3/4" X 4"	34	PVC-AN-07504
PVC-GN-07505	3/4" X 5"	43	PVC-AN-07505
PVC-GN-07506	3/4" X 6"	52	PVC-AN-07506
PVC-GN-07508	3/4" X 8"	73	PVC-AN-07508
PVC-GN-07510	3/4" X 10"	89	PVC-AN-07510
PVC-GN-07512	3/4" X 12"	109	PVC-AN-07512
GRC PART NUMBER	TRADE SIZE	Wt. per 100	ALUMINUM PART NUMBER
PVC-GN-150 CL	1-1/2" X CL (1-3/4")	28	PVC-AN-150 CL
PVC-GN-15002	1-1/2" X 2"	34	PVC-AN-15002
PVC-GN-15002N	1-1/2" X 2-1/2"	44	PVC-AN-15002N
PVC-GN-15003	1-1/2" X 3"	56	PVC-AN-15003
PVC-GN-15003N	1-1/2" X 3-1/2"	68	PVC-AN-15003N
PVC-GN-15004	1-1/2" X 4"	80	PVC-AN-15004
PVC-GN-15005	1-1/2" X 5"	103	PVC-AN-15005
PVC-GN-15006	1-1/2" X 6"	122	PVC-AN-15006
PVC-GN-15008	1-1/2" X 8"	170	PVC-AN-15008
PVC-GN-15010	1-1/2" X 10"	216	PVC-AN-15010
PVC-GN-15012	1-1/2" X 12"	260	PVC-AN-15012
GRC PART NUMBER	TRADE SIZE	Wt. per 100	ALUMINUM PART NUMBER
PVC-GN-300 CL	3" X CL (2-5/8")	118	PVC-AN-300 CL
PVC-GN-30003	3" X 3"	130	PVC-AN-30003
PVC-GN-30003N	3" X 3-1/2"	157	PVC-AN-30003N
PVC-GN-30004	3" X 4"	200	PVC-AN-30004
PVC-GN-30005	3" X 5"	260	PVC-AN-30005
PVC-GN-30006	3" X 6"	300	PVC-AN-30006
PVC-GN-30008	3" X 8"	411	PVC-AN-30008
PVC-GN-30010	3" X 10"	528	PVC-AN-30010
PVC-GN-30012	3" X 12"	630	PVC-AN-30012
PVC-GN-20012	2" X 12"	138	PVC-AN-20012

GRC PART NUMBER	TRADE SIZE	Wt. per 100	ALUMINUM PART NUMBER
PVC-GN-500 CL	5" X CL (3")	240	PVC-AN-500 CL
PVC-GN-50005	5" X 5"	480	PVC-AN-50005
PVC-GN-50006	5" X 6"	600	PVC-AN-50006
PVC-GN-50008	5" X 8"	825	PVC-AN-50008
PVC-GN-50010	5" X 10"	1055	PVC-AN-50010
PVC-GN-50012	5" X 12"	1260	PVC-AN-50012

GRC PART NUMBER	TRADE SIZE	Wt. per 100	ALUMINUM PART NUMBER
PVC-GN-100 CL	1" X CL (1-1/2")	16	PVC-AN-100 CL
PVC-GN-10002	1" X 2"	22	PVC-AN-10002
PVC-GN-10002N	1" X 2-1/2"	28	PVC-AN-10002N
PVC-GN-10003	1" X 3"	36	PVC-AN-10003
PVC-GN-10003N	1" X 3-1/2"	43	PVC-AN-10003N
PVC-GN-10004	1" X 4"	49	PVC-AN-10004
PVC-GN-10005	1" X 5"	64	PVC-AN-10005
PVC-GN-10006	1" X 6"	78	PVC-AN-10006
PVC-GN-10008	1" X 8"	109	PVC-AN-10008
PVC-GN-10010	1" X 10"	138	PVC-AN-10010
PVC-GN-10012	1" X 12"	166	PVC-AN-10012

GRC PART NUMBER	TRADE SIZE	Wt. per 100	ALUMINUM PART NUMBER
PVC-GN-200 CL	2" X CL (2")	16	PVC-AN-200 CL
PVC-GN-20002N	2" X 2-1/2"	22	PVC-AN-20002N
PVC-GN-20003	2" X 3"	28	PVC-AN-20003
PVC-GN-20003N	2" X 3-1/2"	36	PVC-AN-20003N
PVC-GN-20004	2" X 4"	43	PVC-AN-20004
PVC-GN-20005	2" X 5"	49	PVC-AN-20005
PVC-GN-20006	2" X 6"	64	PVC-AN-20006
PVC-GN-20008	2" X 8"	78	PVC-AN-20008
PVC-GN-20010	2" X 10"	109	PVC-AN-20010
PVC-GN-20012	2" X 12"	138	PVC-AN-20012

GRC PART NUMBER	TRADE SIZE	Wt. per 100	ALUMINUM PART NUMBER
PVC-GN-350 CL	3-1/2" X CL (2-3/4")	160	PVC-AN-350 CL
PVC-GN-35004	3-1/2" X 4"	240	PVC-AN-35004
PVC-GN-35005	3-1/2" X 5"	320	PVC-AN-35005
PVC-GN-35006	3-1/2" X 6"	373	PVC-AN-35006
PVC-GN-35008	3-1/2" X 8"	510	PVC-AN-35008
PVC-GN-35010	3-1/2" X 10"	655	PVC-AN-35010
PVC-GN-35012	3-1/2" X 12"	785	PVC-AN-35012

GRC PART NUMBER	TRADE SIZE	Wt. per 100	ALUMINUM PART NUMBER
PVC-GN-600 CL	6" X CL (3")	350	PVC-AN-600 CL
PVC-GN-60005	6" X 5"	660	PVC-AN-60005
PVC-GN-60006	6" X 6"	820	PVC-AN-60006
PVC-GN-60008	6" X 8"	1125	PVC-AN-60008
PVC-GN-60010	6" X 10"	1440	PVC-AN-60010
PVC-GN-60012	6" X 12"	1720	PVC-AN-60012

BlackGuard PVC Coated FS/FD Boxes*/**

FS/FD SINGLE GANG BOXES							
Part Number	SIZE	A	B	C	D	Wt. per 100	ALUMINIM Part Number
PF-FBOX-FS050	1/2"	0.88	1.92	1.69	0.67	320	PFA-FBOX-FS050
PF-FBOX-FS075	3/4"	0.88	1.92	1.69	0.79	330	PFA-FBOX-FS075
PF-FBOX-FS100	1"	1.00	1.92	1.69	0.92	350	PFA-FBOX-FS100
PF-FBOX-FD050	1/2"	0.88	2.69	2.50	0.67	270	PFA-FBOX-FD050
PF-FBOX-FD075	3/4"	0.88	2.69	2.50	0.79	280	PFA-FBOX-FD075
PF-FBOX-FD100	1"	1.00	2.69	2.50	0.92	310	PFA-FBOX-FD100

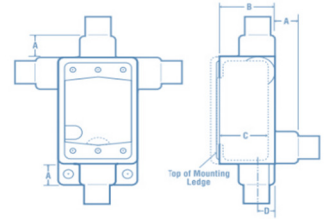

FS/FD TWO GANG BOXES							
Part Number	SIZE	A	B	C	D	Wt. per 100	ALUMINIM Part Number
PF-FBOX-FS0502	1/2"	0.88	1.92	1.69	0.67	330	PFA-FBOX-FS0502
PF-FBOX-FS0752	3/4"	0.88	1.92	1.69	0.79	340	PFA-FBOX-FS0752
PF-FBOX-FS1002	1"	1.00	1.92	1.69	0.92	360	
PF-FBOX-FD0502	1/2"	0.88	2.69	2.50	0.67	330	
PF-FBOX-FD0752	3/4"	0.88	2.69	2.50	0.79	330	PFA-FBOX-FD0752
PF-FBOX-FD1002	1"	1.00	2.69	2.50	0.92	360	

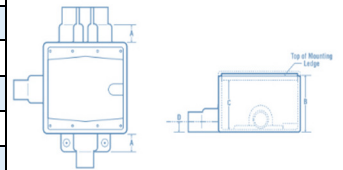

***Covers sold separately **Various styles available**

FS/FD SINGLE GANG COVERS		
Part Number	A	Wt. per 100
PF-FBOXC-DS21	Round Receptacle	300
PF-FBOXC-DS21G	Malleable Round Receptacle	300
PF-FBOXC-DS23	Duplex Convenience Receptacle	300
PF-FBOXC-DS23G	Malleable Duplex Convenience Receptacle	400
PF-FBOXC-DS32	General Switch	400
PF-FBOXC-DS32G	Malleable General Switch	400
PF-FBOXC-DS35	Round Flush Receptacle	400
PF-FBOXC-DS100	Blank Cover	100
PF-FBOXC-DS100G	Malleable Blank Cover	300

FS/FD TWO GANG COVERS		
Part Number	A	Wt. per 100
PF-FBOXC-S1002	Blank Cover	100
PF-FBOXC-S1002G	Malleable Blank Cover	100
PF-FBOXC-S232	Duplex Convenience Receptacle - Stamped	120
PF-FBOXC-S232G	Malleable Duplex Convenience Receptacle	400

BlackGuard PVC Coated Form 8 Fittings*

C - FORM 8

Part Number	SIZE	Metri c	A	B	C	D	E	Wt. per 100	ALUMINIM Part Number
PF-8C-050	1/2"	16	6.69	1.48	1.46	1.00	3.31	200	PFA-7C-050
PF-8C-075	3/4"	21	7.78	1.73	1.27	1.19	3.94	230	PFA-7C-075
PF-8C-100	1"	27	9.31	11.50	1.83	1.38	4.56	280	PFA-7C-100
PF-8C-125	1-1/4"	35	11.00	11.50	2.27	1.75	5.31	450	PFA-7C-125
PF-8C-150	1-1/2"	41	13.38	11.50	2.83	2.13	6.50	650	PFA-7C-150
PF-8C-200	2"	53	14.25	11.50	3.83	3.00	8.56	1030	PFA-7C-200
PF-8C-250	2-1/2"	63	17.63	8.00	5.08	4.25	10.80	1800	PFA-7C-250
PF-8C-300	3"	78	17.63	8.00	5.08	4.25	10.88	2050	PFA-7C-300
PFA-9C-350	3-1/2"	91	20.75	8.00	6.33	5.44	13.44	1000	PFA-9C-350
PFA-9C-400	4"	103	20.75	8.00	6.33	5.44	13.44	1200	PFA-9C-400



LB - FORM 8

Part Number	SIZE	Metri c	A	B	C	D	E	Wt. per 100	ALUMINIM Part Number
PF-8LB-050	1/2"	16	5.48	2.26	1.42	1.00	3.31	150	PFA-7LB-050
PF-8LB-075	3/4"	21	6.35	2.48	1.60	1.19	3.94	200	PFA-7LB-075
PF-8LB-100	1"	27	7.51	2.85	1.79	1.38	4.56	290	PFA-7LB-100
PF-8LB-125	1-1/4"	35	8.82	3.38	2.23	1.75	5.31	410	PFA-7LB-125
PF-8LB-150	1-1/2"	41	10.67	4.07	2.79	2.13	6.50	650	PFA-7LB-150
PF-8LB-200	2"	53	13.04	4.85	3.79	3.00	8.50	820	PFA-7LB-200
PF-8LB-250	2-1/2"	63	15.98	6.17	5.04	4.25	10.88	1820	PFA-7LB-250
PF-8LB-300	3"	78	15.98	6.54	5.04	4.25	10.88	2120	PFA-7LB-300
PF-8LB-350	3-1/2"	91	14.73	7.60	6.29	5.44	5.44	3120	PFA-7LB-350
PF-8LB-400	4"	103	14.73	7.85	6.29	5.44	5.44	3200	PFA-7LB-400

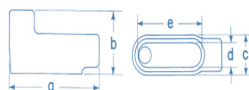

LL - FORM 8

Part Number	SIZE	Metri c	A	B	C	D	E	Wt. per 100	ALUMINIM Part Number
PF-8LL-050	1/2"	16	5.48	1.48	2.20	1.00	3.31	150	PFA-7LL-050
PF-8LL-075	3/4"	21	6.35	1.73	2.35	1.19	3.94	200	PFA-7LL-075
PF-8LL-100	1"	27	7.51	1.98	2.67	1.38	4.56	290	PFA-7LL-100
PF-8LL-125	1-1/4"	35	8.82	2.42	3.20	1.75	5.31	410	PFA-7LL-125
PF-8LL-150	1-1/2"	41	10.67	2.82	4.40	2.13	6.50	650	PFA-7LL-150
PF-8LL-200	2"	53	13.04	3.60	5.04	3.00	8.56	820	PFA-7LL-200
PF-8LL-250	2-1/2"	63	15.98	4.48	6.73	4.25	10.88	1820	PFA-7LL-250
PF-8LL-300	3"	78	15.98	4.85	6.73	4.25	10.88	2120	PFA-7LL-300
PFA-9LL-350	3-1/2"	91	14.73	1.92	6.98	4.50	10.25	3120	PFA-7LL-350
PFA-9LL-400	4"	103	14.73	5.42	6.98	4.50	10.25	3200	PFA-7LL-400

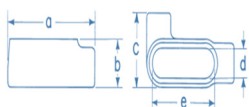

*Fittings available in Form 7

BlackGuard PVC Coated Form 8 Fittings*

LR - FORM 8

Part Number	SIZE	Metric	A	B	C	D	E	Wt. per 100	ALUMINIM Part Number
PF-8LR-050	1/2"	16	5.48	1.48	2.20	1.00	3.31	150	PFA-7LR-050
PF-8LR-075	3/4"	21	6.35	1.73	2.35	1.19	3.94	200	PFA-7LR-075
PF-8LR-100	1"	27	7.51	0.98	2.67	1.38	4.56	290	PFA-7LR-100
PF-8LR-125	1-1/4"	35	8.82	2.42	3.20	1.75	5.31	410	PFA-7LR-125
PF-8LR-150	1-1/2"	41	10.67	2.82	4.04	2.13	6.50	650	PFA-7LR-150
PF-8LR-200	2"	53	13.04	3.60	5.04	3.00	8.56	820	PFA-7LR-200
PF-8LR-250	2-1/2"	63	15.98	4.48	6.73	4.25	10.88	1820	PFA-7LR-250
PF-8LR-300	3"	78	15.98	4.85	6.73	4.25	10.88	2120	PFA-7LR-300
PFA-9LR-350	3-1/2"	91	14.73	4.92	6.98	4.50	10.25	3120	PFA-7LR-350
PFA-9LR-400	4"	103	14.73	5.42	6.98	4.50	10.25	3200	PFA-7LR-400

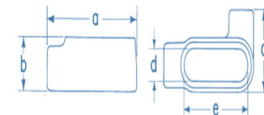

T - FORM 8

Part Number	SIZE	Metric	A	B	C	D	E	Wt. per 100	ALUMINIM Part Number
PF-8T-050	1/2"	16	6.69	1.79	2.20	1.00	3.31	180	PFA-7T-050
PF-8T-075	3/4"	21	7.78	2.04	2.35	1.90	3.94	250	PFA-7T-075
PF-8T-100	1"	27	9.31	2.29	2.67	1.38	4.56	330	PFA-7T-100
PF-8T-125	1-1/4"	35	11.00	2.67	3.20	1.75	5.31	490	PFA-7T-125
PF-8T-150	1-1/2"	41	13.38	2.82	4.04	2.13	6.50	750	PFA-7T-150
PF-8T-200	2"	53	16.25	3.60	5.04	3.00	8.56	1170	PFA-7T-200
PF-8T-250	2-1/2"	63	19.63	4.48	6.73	4.25	10.88	1980	PFA-7T-250
PF-8T-300	3"	78	19.63	4.85	6.73	4.25	10.88	2350	PFA-7T-300
PFA-9T-350	3-1/2"	91	22.75	5.73	8.17	5.44	13.44	2100	PFA-7T-350
PFA-9T-400	4"	103	22.75	5.98	8.17	5.44	13.44	2400	PFA-7T-400

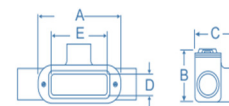

TB - FORM 8

Part Number	SIZE	Metric	A	B	C	D	E	Wt. per 100	ALUMINIM Part Number
PF-8TB-050	1/2"	16	6.69	3.57	1.46	1.00	3.31	180	PFA-7TB-050
PF-8TB-075	3/4"	21	7.78	3.79	1.67	1.90	3.94	250	PFA-7TB-075
PF-8TB-100	1"	27	9.31	4.17	1.83	1.38	4.56	330	PFA-7TB-100
PF-8TB-125	1-1/4"	35	11.00	4.38	2.27	1.75	5.31	490	PFA-7TB-125
PF-8TB-150	1-1/2"	41	13.38	5.07	2.83	2.13	6.50	750	PFA-7TB-150
PF-8TB-200	2"	53	16.25	5.85	3.83	3.00	8.56	1170	PFA-7TB-200

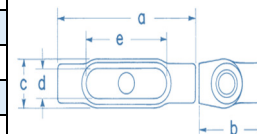

X - FORM 8

Part Number	SIZE	Metric	A	B	C	D	E	Wt. per 100	ALUMINIM Part Number
PF-8X-050	1/2"	16	6.69	3.91	1.79	1.00	3.31	180	PFA-7X-050
PF-8X-075	3/4"	21	7.78	4.56	2.04	1.90	3.94	250	PFA-7X-075
PF-8X-100	1"	27	9.31	5.50	2.29	1.38	4.56	330	PFA-7X-100
PF-8X-125	1-1/4"	35	11.00	6.63	2.67	1.75	5.31	490	PFA-7X-125
PF-8X-150	1-1/2"	41	13.38	8.25	2.50	2.13	6.50	750	PFA-7X-150
PF-8X-200	2"	53	16.25	10.25	3.60	3.00	8.56	1170	PFA-7X-200

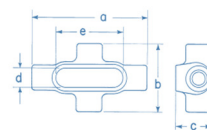

*Fitting available in Form 7

BlackGuard PVC Coated GUA Boxes*

GUAB								
Part Number	SIZE	Cover Opening	A	B	C	D	Wt. per 100	ALUMINIM Part Number
PF-GUAB-05014	1/2"	2"	2.58	2.29	2.19	0.67	200	PFA-GUAB05014
PF-GUAB-05016	1/2"	3"	3.58	2.04	1.88	0.67	320	PFA-GUAB-05016
PF-GUAB-07524	3/4"	2"	2.58	2.54	2.44	0.79	220	
PF-GUAB-07526	3/4"	3"	3.58	2.04	1.88	0.79	330	PFA-GUAB-07526
PF-GUAB-10036	1"	3"	3.58	2.35	2.19	0.92	380	PFA-GUAB-10036
PF-GUAB-12547	1-1/4"	3-5/8"	4.33	2.73	2.75	1.13	500	PFA-GUAB-12547
PF-GUAB-15059	1-1/2"	5"	5.83	3.85	3.75	1.32	810	PFA-GUAB-15059
PF-GUAB-20069	2"	5"	5.83	4.10	4.00	1.60	910	PFA-GUAB-20069

GUAC								
Part Number	SIZE	Cover Opening	A	B	C	D	Wt. per 100	ALUMINIM Part Number
PF-GUAC-05014	1/2"	2"	2.58	2.29	2.19	0.67	350	PFA-GUAC-05014
PF-GUAC-05016	1/2"	3"	3.58	2.04	1.88	0.67	200	PFA-GUAC-05016
PF-GUAC-07524	3/4"	2"	2.58	2.54	2.44	0.79	350	PFA-GUAC-05024
PF-GUAC-07526	3/4"	3"	3.58	2.04	1.88	0.79	200	PFA-GUAC-07526
PF-GUAC-10036	1"	3"	3.58	2.35	2.19	0.92	390	PFA-GUAC-10036
PF-GUAC-12547	1-1/4"	3-5/8"	4.33	2.73	2.75	1.13	520	PFA-GUAC-12547
PF-GUAC-12549	1-1/4"	5"	5.83	3.85	3.75	1.32	950	
PF-GUAC-15059	2"	5"	5.83	3.85	3.75	1.32	1100	PFA-GUAC-15059
PF-GUAC-12549	1-1/2"	5"	5.83	4.40	4.00	1.60	1100	

GUAT								
Part Number	SIZE	Cover Opening	A	B	C	D	Wt. per 100	ALUMINIM Part Number
PF-GUAT-05014	1/2"	2"	2.58	2.29	2.19	0.67	200	PFA-GUAT-05014
PF-GUAT-05016	1/2"	3"	3.58	2.04	1.88	0.67	320	PFA-GUAT-05016
PF-GUAT-07524	3/4"	2"	2.58	2.04	2.00	0.79	220	PFA-GUAT-07524
PF-GUAT-07526	3/4"	3"	3.58	2.04	1.88	0.79	330	PFA-GUAT-07526
PF-GUAT-10036	1"	3"	3.58	2.35	2.19	0.92	380	PFA-GUAT-10036
PF-GUAT-12547	1-1/4"	3-5/8"	4.33	2.73	2.75	1.13	500	PFA-GUAT-12547
PF-GUAT-15059	1-1/2"	5"	5.83	3.85	3.75	1.32	810	PFA-GUAT-15059
PF-GUAT-20069	2"	5"	5.83	4.10	4.00	1.60	910	PFA-GUAT-20069

GUAX								
Part Number	SIZE	Cover Opening	A	B	C	D	Wt. per 100	ALUMINIM Part Number
PF-GUAX-05014	1/2"	2"	2.58	1.85	7.50	0.67	200	
PF-GUAX-05016	1/2"	3"	3.58	2.04	1.88	0.67	320	PFA-GUAX-05016
PF-GUAX-07524	3/4"	2"	2.58	2.04	2.00	0.79	220	PFA-GUAX-07524
PF-GUAX-07526	3/4"	3"	3.58	2.04	1.88	0.79	330	PFA-GUAX-07526
PF-GUAX-10036	1"	3"	3.58	2.35	2.19	0.92	380	PFA-GUAX-10036
PF-GUAX-12547	1-1/4"	3-5/8"	4.33	2.73	2.75	1.13	500	PFA-GUAX-12547
PF-GUAX-15059	1-1/2"	5"	5.83	3.85	3.75	1.32	810	PFA-GUAX-15059
PF-GUAX-20069	2"	5"	5.83	4.10	4.00	1.60	910	PFA-GUAX-20069

***Various GUA boxes available – Consult Factory**

BlackGuard PVC Coated Seal Fittings*

EYS Female Hubs

Part Number	SIZE	A	B	Wt. per 100
Vertical sealing positions only				
PF-EYS-0501	1/2"	4.28	1.33	100
PF-EYS-0752	3/4"	5.25	1.58	150
PF-EYS-1003	1"	6.31	1.83	210
Vertical or Horizontal sealing positions				
PF-EYS-1254	1-1/4"	7.56	2.27	270
PF-EYS-1505	1-1/2"	8.5	2.52	370
PF-EYS-2006	2"	10.25	3.08	470
PF-EYS-2507	2-1/2"	11.5	3.58	1000
PF-EYS-3008	3"	12.5	4.33	1120
PF-EYS-3509	3-1/2"	13.19	4.83	1450
PF-EYS-40010	4"	13.75	5.33	1600

EYS Male / Female Hubs

Part Number	SIZE	A	B	Wt. per 100
PF-EYS-050116	1/2"	5.19	1.33	150
PF-EYS-075216	3/4"	5.19	1.58	120
PF-EYS-100316	1"	6.31	1.83	260
PF-EYS-12546	1-1/4"	7.56	2.27	280
PF-EYS-15056	1-1/2"	8.5	2.52	370
PF-EYS-20066	2"	10.25	3.08	560
PF-EYS-25076	2-1/2"	11.5	3.58	1320
PF-EYS-30086	3"	12.5	4.33	1120
PF-EYS-35096	3-1/2"	13.19	4.83	1450
PF-EYS-400106	4"	13.75	5.33	1500

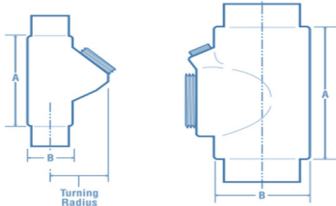

*Various seal fittings available (including Aluminum)
Consult factory

BlackGuard PVC Coated Conduit Hubs*

Part Number	SIZE	A	B	C	Wt. per 100	ALUMINIM Part Number
PF-HUB-ST050	1/2"	1.84	2.00	1.31	20	PFA-HUB-ST050
PF-HUB-ST075	3/4"	2.22	2.25	1.66	30	PFA-HUB-ST075
PF-HUB-ST100	1"	2.66	2.50	2.03	40	PFA-HUB-ST100
PF-HUB-ST125	1-1/4"	2.94	3.25	2.28	40	PFA-HUB-ST125
PF-HUB-ST150	1-1/2"	3.19	3.50	2.53	60	PFA-HUB-ST150
PF-HUB-ST200	2"	3.75	4.25	3.09	120	PFA-HUB-ST200
PF-HUB-ST250	2-1/2"	4.22	4.75	3.28	150	PFA-HUB-ST250
PF-HUB-ST300	3"	4.31	5.25	3.38	210	PFA-HUB-ST300
PF-HUB-ST350	3-1/2"	4.38	5.50	3.44	300	PFA-HUB-ST350
PF-HUB-ST400	4"	4.44	6.25	3.50	350	PFA-HUB-ST400
PF-HUB-ST500	5"	4.94	7.50	4.00	540	PFA-HUB-ST500
PF-HUB-ST600	6"	5.00	8.50	4.00	690	PFA-HUB-ST600

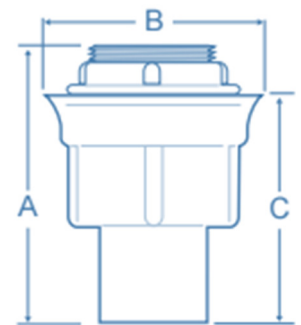

*Available with Grounding

BlackGuard PVC Coated Unions

UNF Female Unions

Part Number	SIZE	Length	Max Diameter	Wt. per 100	ALUMINIM Part Number
PF-UNF-050	1/2"	2.81	1.58	30	PFA-UNF-050
PF-UNF-075	3/4"	3.25	1.89	50	PFA-UNF-075
PF-UNF-075050	3/4"-1/2"	3.00	1.89	60	
PF-UNF-100	1"	4.00	1.96	70	PFA-UNF-100
PF-UNF-125	1-1/4"	4.75	2.83	150	PFA-UNF-125
PF-UNF-150	1-1/2"	5.63	3.14	230	PFA-UNF-150
PF-UNF-200	2"	6.56	3.89	360	PFA-UNF-200
PF-UNF-250	2-1/2"	7.19	4.39	500	PFA-UNF-250
PF-UNF-300	3"	7.44	5.14	650	PFA-UNF-300
PF-UNF-350	3-1/2"	8.13	5.77	820	PFA-UNF-350
PF-UNF-400	4"	8.13	6.27	1000	PFA-UNF-400
PF-UNF-500	5"	7.81	8.27	1250	
PF-UNF-600	6"	7.81	9.39	1480	

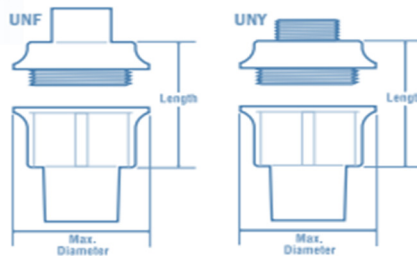

UNF Male-Female Unions

Part Number	SIZE	Length	Max Diameter	Wt. per 100	ALUMINIM Part Number
PF-UNY-050	1/2"	3.38	1.58	40	PFA-UNY-050
PF-UNY-075	3/4"	3.94	1.89	70	PFA-UNY-075
PF-UNY-075050	3/4"-1/2"	3.69	1.89	80	
PF-UNY-100	1"	4.75	1.96	130	PFA-UNY-100
PF-UNY-125	1-1/4"	5.69	2.83	260	PFA-UNY-125
PF-UNY-150	1-1/2"	6.56	3.14	390	PFA-UNY-150
PF-UNY-200	2"	7.75	3.89	420	PFA-UNY-200
PF-UNY-250	2-1/2"	8.63	4.39	550	PFA-UNY-250
PF-UNY-300	3"	9.00	5.14	750	PFA-UNY-300
PF-UNY-350	3-1/2"	9.50	5.77	840	PFA-UNY-350
PF-UNY-400	4"	9.63	6.27	1050	PFA-UNY-400
PF-UNY-500	5"	9.25	8.27	1200	
PF-UNY-600	6"	9.38	9.39	1490	

BlackGuard PVC Coated Liquidtight Connectors*

Straight Connectors

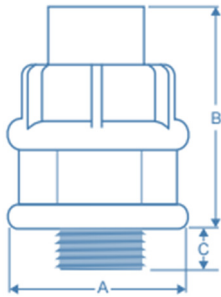

Part Number	SIZE	A	B	C	Wt. per 100	ALUMINIM Part Number
PF-LT-0375	3/8"	1.24	1.88	0.56	20	PFA-LT-0375
PF-LT-050	1/2"	1.46	2.06	0.56	20	PFA-LT-050
PF-LT-075	3/4"	1.74	2.38	0.56	30	PFA-LT-075
PF-LT-100	1"	1.96	3.06	0.75	40	PFA-LT-100
PF-LT-125	1-1/4"	2.36	3.75	0.81	80	PFA-LT-125
PF-LT-150	1-1/2"	2.80	4.19	0.81	90	PFA-LT-150
PF-LT-200	2"	3.33	5.06	0.88	170	PFA-LT-200
PF-LT-250	2-1/2"	3.83	6.13	1.00	300	PFA-LT-250
PF-LT-300	3"	4.58	6.25	1.00	420	PFA-LT-300
PF-LT-400	4"	5.58	6.50	1.13	620	PFA-LT-400

90* Connectors

Part Number	SIZE	A	B	C	Wt. per 100	ALUMINIM Part Number
PF-LT90-0375	3/8"	1.24	1.80	0.56	20	PFA-LT90-0375
PF-LT90-050	1/2"	1.46	2.10	0.56	20	PFA-LT90-050
PF-LT90-075	3/4"	1.74	2.54	0.56	30	PFA-LT90-075
PF-LT90-100	1"	1.96	3.23	0.75	40	PFA-LT90-100
PF-LT90-125	1-1/4"	2.36	4.04	0.81	80	PFA-LT90-125
PF-LT90-150	1-1/2"	2.80	4.48	0.81	90	PFA-LT90-150
PF-LT90-200	2"	3.33	5.48	0.88	170	PFA-LT90-200
PF-LT90-250	2-1/2"	3.83	10.92	1.00	300	PFA-LT90-250
PF-LT90-300	3"	4.58	12.30	1.00	420	PFA-LT90-300
PF-LT90-400	4"	5.58	14.70	1.13	620	PFA-LT90-400

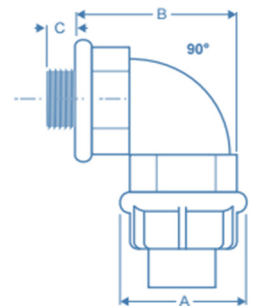

45* Connectors

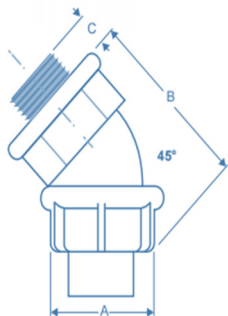

Part Number	SIZE	A	B	C	Wt. per 100	ALUMINIM Part Number
PF-LT45-0375	3/8"	1.24	1.94	0.56	20	PFA-LT45-0375
PF-LT45-050	1/2"	1.46	2.38	0.56	20	PFA-LT45-050
PF-LT45-075	3/4"	1.74	2.88	0.56	30	PFA-LT45-075
PF-LT45-100	1"	1.96	3.25	0.75	40	PFA-LT45-100
PF-LT45-125	1-1/4"	2.36	4.00	0.81	80	PFA-LT45-125
PF-LT45-150	1-1/2"	2.80	4.88	0.81	90	PFA-LT45-150
PF-LT45-200	2"	3.33	5.88	0.88	170	PFA-LT45-200
PF-LT45-250	2-1/2"	3.83	6.25	1.00	300	PFA-LT45-250
PF-LT45-300	3"	4.58	6.25	1.00	420	PFA-LT45-300
PF-LT45-400	4"	5.58	6.63	1.13	620	PFA-LT45-400

*Available with Grounding

BlackGuard PVC Coated Accessories

Reducing Bushing*		
Part Number	SIZE	Wt. per 100
PF-RB-075050	3/4" - 1/2"	20
PF-RB-100050	1" - 1/2"	70
PF-RB-100075	1" - 3/4"	50
PF-RB-125050	1-1/4" - 3/4"	80
PF-RB-125075	1-1/4" - 1"	80
PF-RB-125100	1-1/2" - 3/4"	80
PF-RB-150050	1-1/2" - 1/2"	90
PF-RB-150075	1-1/2" - 3/4"	90
PF-RB-150100	1-1/2" - 1"	90
PF-RB-150125	1-1/2" - 1-1/4"	90
PF-RB-200050	2" - 1/2"	110
PF-RB-200075	2" - 3/4"	110
PF-RB-200100	2" - 1"	120
PF-RB-200125	2" - 1-1/4"	130
PF-RB-200150	2" - 1-1/2"	160
PF-RB-250100	2-1/2" - 1"	160
PF-RB-250125	2-1/2" - 1-1/4"	160

Reducing Bushing*		
Part Number	SIZE	Wt. per 100
PF-RB-250150	2-1/2" - 1-1/2"	160
PF-RB-250200	2-1/2" - 2"	170
PF-RB-300100	3" - 1"	170
PF-RB-300125	3" - 1-1/4"	230
PF-RB-300150	3" - 1-1/2"	240
PF-RB-300200	3" - 2"	250
PF-RB-300250	3" - 2-1/2"	400
PF-RB-350200	3-1/2" - 2"	460
PF-RB-350250	3-1/2" - 2-1/2"	470
PF-RB-350300	3-1/2" - 3"	480
PF-RB-400200	4" - 2"	500
PF-RB-400250	4" - 2-1/2"	520
PF-RB-400300	4" - 3"	600
PF-RB-400350	4" - 3-1/2"	610
PF-RB-500400	5" - 4"	740
PF-RB-600500	6" - 5"	800

*Available in Aluminium

Reducing Coupling*		
Part Number	SIZE	Wt. per 100
PF-RC-075050	3/4" - 1/2"	20
PF-RC-100050	1" - 1/2"	70
PF-RC-100075	1" - 3/4"	50
PF-RC-125075	1-1/4" - 3/4"	100
PF-RC-125100	1-1/4" - 1"	80
PF-RC-150075	1-1/2" - 3/4"	140
PF-RC-150100	1-1/2" - 1"	120
PF-RC-150125	1-1/2" - 1-1/4"	130
PF-RC-200075	2" - 3/4"	150
PF-RC-200100	2" - 1"	230
PF-RC-200125	2" - 1-1/4"	260
PF-RC-200150	2" - 1-1/2"	280
PF-RC-250150	2-1/2" - 1-1/2"	320
PF-RC-300200	3" - 2"	370
PF-RC-350250	3-1/2" - 2-1/2"	460
PF-RC-400300	4" - 3"	590
PF-RC-500400	5" - 4"	74

Recessed Plugs		
Part Number	SIZE	Wt. per 100
PF-PLG-RE050	1/2"	20
PF-PLG-RE075	3/4"	20
PF-PLG-RE100	1"	30
PF-PLG-RE125	1-1/4"	30
PF-PLG-RE150	1-1/2"	30
PF-PLG-RE200	2"	30
PF-PLG-RE250	2-1/2"	30
PF-PLG-RE300	3"	40
PF-PLG-RE350	3-1/2"	40
PF-PLG-RE400	4"	50

Square Head Plugs		
Part Number	SIZE	Wt. per 100
PF-PLG-SQ050	1/2"	50
PF-PLG-SQ075	3/4"	60
PF-PLG-SQ100	1"	20
PF-PLG-SQ125	1-1/4"	30
PF-PLG-SQ150	1-1/2"	30
PF-PLG-SQ200	2"	40
PF-PLG-SQ250	2-1/2"	40
PF-PLG-SQ300	3"	50
PF-PLG-SQ350	3-1/2"	50
PF-PLG-SQ400	4"	60

*Available in Aluminium

BlackGuard PVC Coated Accessories

1-Hole Malleable Straps		
Part Number	SIZE	Wt. per 100
PF-STRP1-050	1/2"	110
PF-STRP1-075	3/4"	140
PF-STRP1-100	1"	120
PF-STRP1-125	1-1/4"	250
PF-STRP1-150	1-1/2"	360
PF-STRP1-200	2"	710
PF-STRP1-250	2-1/2"	1100
PF-STRP1-300	3"	1340
PF-STRP1-350	3-1/2"	1660
PF-STRP1-400	4"	2560

Clampback Spacers		
Part Number	SIZE	Wt. per 100
PF-STRPCB-050	1/2"	10
PF-STRPCB-075	3/4"	10
PF-STRPCB-100	1"	10
PF-STRPCB-125	1-1/4"	20
PF-STRPCB-150	1-1/2"	20
PF-STRPCB-200	2"	30
PF-STRPCB-250	2-1/2"	100
PF-STRPCB-300	3"	170
PF-STRPCB-350	3-1/2"	190
PF-STRPCB-400	4"	200

2-Hole Stamp Steel Straps		
Part Number	SIZE	Wt. per 100
PF-STRP2-050	1/2"	200
PF-STRP2-075	3/4"	300
PF-STRP2-100	1"	400
PF-STRP2-125	1-1/4"	450
PF-STRP2-150	1-1/2"	500
PF-STRP2-200	2"	1000
PF-STRP2-250	2-1/2"	1300
PF-STRP2-300	3"	1700
PF-STRP2-350	3-1/2"	2000
PF-STRP2-400	4"	2500

Conduit Hangers		
Part Number	SIZE	Wt. per 100
PF-CH-050	1/2"	100
PF-CH-075	3/4"	100
PF-CH-100	1"	100
PF-CH-125	1-1/4"	100
PF-CH-150	1-1/2"	200
PF-CH-200	2"	300
PF-CH-250	2-1/2"	400
PF-CH-300	3"	500
PF-CH-350	3-1/2"	600
PF-CH-400	4"	700

Right Angle Clamps		
Part Number	SIZE	Wt. per 100
PF-CLPR-050	1/2"	49
PF-CLPR-075	3/4"	53
PF-CLPR-100	1"	61
PF-CLPR-125	1-1/4"	65
PF-CLPR-150	1-1/2"	92
PF-CLPR-200	2"	100
PF-CLPR-250	2-1/2"	125
PF-CLPR-300	3"	150
PF-CLPR-350	3-1/2"	175
PF-CLPR-400	4"	198

Parallel Clamps		
Part Number	SIZE	Wt. per 100
PF-CLPP-050	1/2"	47
PF-CLPP-075	3/4"	63
PF-CLPP-100	1"	67
PF-CLPP-125	1-1/4"	100
PF-CLPP-150	1-1/2"	130
PF-CLPP-200	2"	158
PF-CLPP-250	2-1/2"	175
PF-CLPP-300	3"	200
PF-CLPP-350	3-1/2"	250
PF-CLPP-400	4"	275

BlackGuard PVC Coated Accessories

Channel - Ferrous			
Part Number	STYLE	SIZE	Wt. per 100
PF-USTRUT-DPSOLID	Standard Solid	1-5/8" X 1-5/8"	200
PF-USTRUT-BTB	Back to Back	1-5/8" X 3-1/4"	380
PF-USTRUT-DPSLOTTED	Slotted Standard	1-5/8" X 1-5/8"	185
PF-USTRUT-SHSOLID	Shallow Solid	1-5/8" X 7/8"	135
PF-USTRUT-SHSLOTTED	Shallow Slotted	1-5/8" X 7/8"	130

Strut Straps			
Part Number	SIZE	Wt. per 100	ALUMINIM Part Number
PF-USTRP-050	1/2"	14	PFA-USTRP-050
PF-USTRP-075	3/4"	15	PFA-USTRP-075
PF-USTRP-100	1"	18	PFA-USTRP-100
PF-USTRP-125	1-1/4"	23	PFA-USTRP-125
PF-USTRP-150	1-1/2"	22	PFA-USTRP-150
PF-USTRP-200	2"	40	PFA-USTRP-200
PF-USTRP-250	2-1/2"	41	PFA-USTRP-250
PF-USTRP-300	3"	39	PFA-USTRP-300
PF-USTRP-350	3-1/2"	52	PFA-USTRP-350
PF-USTRP-400	4"	61	PFA-USTRP-400
PF-USTRP-500	5"	76	PFA-USTRP-500

Grounding Bushings		
Part Number	SIZE	Wt. per 100
PF-GB-050	1/2"	10
PF-GB-075	3/4"	10
PF-GB-100	1"	10
PF-GB-125	1-1/4"	20
PF-GB-150	1-1/2"	20
PF-GB-200	2"	30
PF-GB-250	2-1/2"	50
PF-GB-300	3"	70
PF-GB-350	3-1/2"	100
PF-GB-400	4"	110

Split Couplings		
Part Number	SIZE	Wt. per 100
PF-SC-050	1/2"	20
PF-SC-075	3/4"	30
PF-SC-100	1"	40
PF-SC-125	1-1/4"	60
PF-SC-150	1-1/2"	70
PF-SC-200	2"	100
PF-SC-250	2-1/2"	230
PF-SC-300	3"	300
PF-SC-350	3-1/2"	380
PF-SC-400	4"	410
PF-SC-500	3-1/2"	600
PF-SC-600	4"	860

BLACKGUARD TERMS & CONDITIONS

- Acceptance:** All orders are subject to acceptance by NEC, Inc.
- Minimum Billing:** \$250.00* - orders of less than \$250 net value will be invoiced at \$250
- Payment Terms:** 2% 10th Prox., Net 31 days, pending credit authorization
- Delivery:** Delivery date given prior to or after placement of an order is determined to the best of our ability based on our normal production cycle. The delivery date is in no way guaranteed unless otherwise specified in writing. Therefore, NEC Inc is not indemnitor for any damages, losses, or claims whatsoever due to inability to meet such delivery date.
- Freight Policy:** F.O.B. point of shipment.
- Freight allowance is on conduit & fitting orders exceeding \$7,500.00 (net), based on a single order, which is to be routed in one shipment to a single destination by common carrier via best way.
 - Additional requirements will be handled pre-paid and charged or collect.
 - Shipments will be completed without back orders, if a partial shipment is requested on freight allowed, freight allowance will be allowed on the portion having the greater weight.
 - Purchaser is responsible to immediately inspect all goods at the time of delivery and inform driver of any damages or loss of goods; to facilitate a proper claim.
- Cancellation:** Orders for normal quantities of standard goods may be canceled without charge, if written instructions are received at the factory in time to stop order prior to production. Cancellation of orders for special products; including large radius elbows will not be accepted after order is released.
- Return Policy:** No material will be returned to, or accepted by NEC, Inc without written authorization. Upon authorization, undamaged standard stock items in resalable condition will be considered for return. A minimum restocking charge of 35% of the price originally paid for the material will apply. All transportation to NEC must be prepaid by the customer. Any damages will be reported to person who requested return; NEC will not be responsible for filing damage claims with freight carrier. The credit is subject to our confirmation of quantities and condition of material received. No material will be accepted after sixty days unless written authorization has been obtained at the time the original purchase order was accepted. Material ordered for or shipped to job sites will not be accepted for return under any condition except warranty. Under no condition will large radius elbows be accepted for return except for warranty.
- Shortages:** No shortage claims will be recognized unless such shortage is reported to NEC within five (5) days from receipt of shipment at destination.
- Quote policy:** Quotations are valid for 14 days after issue date, unless otherwise stated. Lead times quoted valid until end of business day.
- Catalog Specification:** Catalog weights and dimensions are careful estimates but are not guaranteed.
- Warranties:** NEC, Inc. warrants **BlackGuard**[™] products manufactured by the company to be free from defects in materials and workmanship for a period of 5 years from the date of shipment from plant. If within such period any such goods shall be proven to NEC's satisfaction to be so defective, then and in that event such equipment shall be repaired or replaced at NEC's option. Such correction or replacement of defective goods shall constitute a fulfillment of all liabilities in respect to such goods. Installation not in accordance with written NEC's recommendations shall void warranty.

CUSTOMIZED PALLETS FOR SHIPPING

